

27962

Load Capacity	8168 lbs
Temp. Range	-10°F to 225°F

Features

- ABEC-1 precision
- Hardened chrome steel
- Precision ground finish
- Spherical all metal body
- Metal adapter sleeve
- Extended inner race with 2 set-screws
- Front & rear rubber seals
- Front & rear shields
- Ball retainer
- Replaceable
- Grease packed

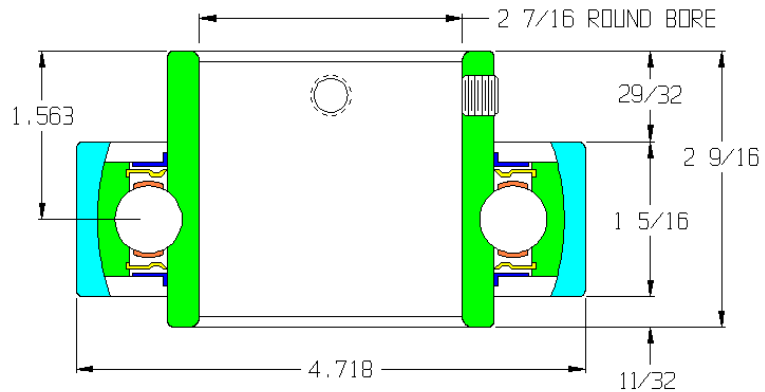

Application Info

Recommended for very heavy loads. The spherical bearing can rotate inside the sleeve so is less affected by axle deflection. Set screws lock the bearing to the axle and prevent side-to-side movement, even if roller is mounted vertically. Metal shields deflect large particle debris and protect a rubber contact seal that is very effective against fine dust and other small particle debris. The seal adds rotational drag and is not recommended for gravity applications with light product. Recommended for powered applications where roller resistance is not an issue and the roller is constantly rotating.

Similar Bearings

45068-GP has a larger sleeve OD.

Special Notes

102218-GP is the bearing part number.
27969 is the sleeve part number.

