

102145-O

Load Capacity	145 lbs
Temp. Range	-40°F to 140°F

Features

- Unground, non-precision
- Stamped metal construction
- Zinc plated mild steel
- Full ball compliment
- Replaceable
- Lightly oiled

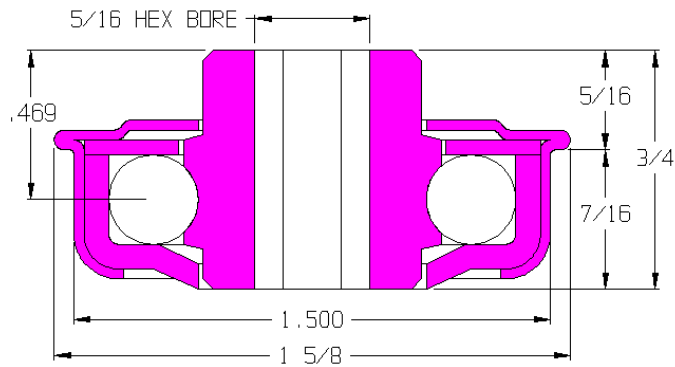

Application Info

Light oil offers very little rotational drag making this bearing excellent for gravity applications. The lack of seals or shields further reduces drag but offers no protection against dirt and debris. Not recommended for dirty or dusty environments. The light oil is not recommended for powered applications where the bearing is rotating continuously.

Similar Bearings

- 102052-O has a 7/16 hex bore.
- 102180-O has a 3/8 hex bore.
- 102181-O has a 1/2 dia. round bore.
- 44832-O has an adapter for 2-1/4 OD tubes.
- 44833-O has an adapter for 2-1/2 OD tubes.

